

# The Renaissance<sup>®</sup>

---

Designed for efficiency, built to last.



# The Renaissance® Design Advantage

■ The RENAISSANCE® Cart was designed using the latest sophisticated computer technology to identify stress points and simulate years of service.

Wanzl is known for the quality and durability of its products. The Renaissance Cart® is now time tested as a proven winner for many retailers who now utilize a plastic shopping cart for their customers.



**1 Interchangeable One-Piece Basket**  
Exclusively attached without the use of rivets, a common area of failure on other plastic cart designs.

**2 High Visibility Basket**  
Provides cashiers with clear vision to all items in the basket, thus reducing theft.

**3 Contemporary Contoured Basket**  
Design reduces the collection of moisture and dirt, reducing slip-and-fall potential, and provides the customer with a clean shopping cart.

**4 Integrated Front Handle**

**5 Modular Design**  
Allows for easy maintenance.

**6 Fixed Lower Grill**  
Eliminates chatter.

**7 Three Logo Panels**  
Optional printing of I.D. or logo on the sides and front (dimensions are 8"x3.5" or 203x83 mm; one color printing only).

**8 Heavy-Gauge Oval Tube Frame**

**9 Unique Steel Gate Design**  
Prevents the gate from dislodging from the basket.

**10 Steel Components include a TECH-SEAL® Finish**  
Steel frame and components come standard in Granite TECH-SEAL® Finish (three-year written warranty against the spread of corrosion).

**Quality\_MADE BY WANZL**



Everything on this cart is recyclable.

# Features, Benefits, and Specs



### Bread Basket Insert & Cup Holder

Optional attachments that increase the functionality of the cart.

- Basket is molded of FDA-approved resin
- Colored baskets available to meet your store decor requirements (options below)
- 10 1/2" nesting distance offers a better utilization of front end space



### Rear Roller Lifter

Raises rear fixed casters when carts are nested and collected (this reduces wheel flat spotting).

### Available Basket Colors

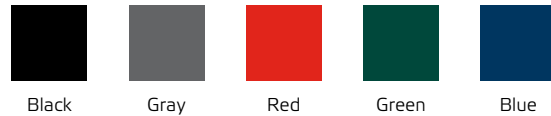

Custom colors available. Call for details.

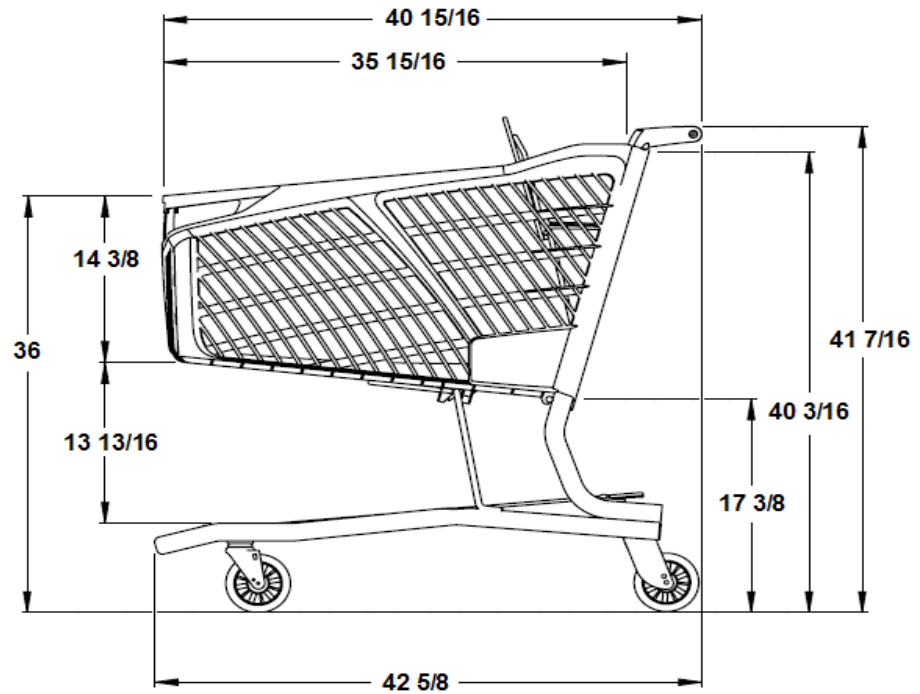
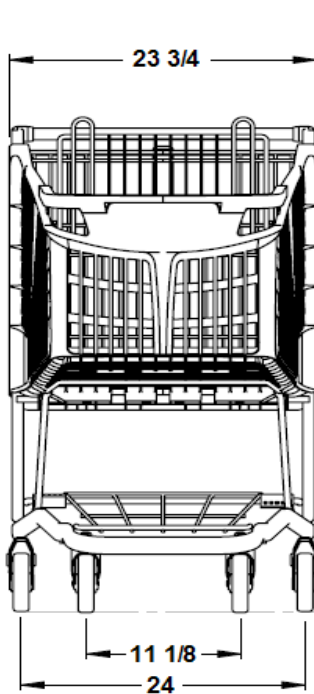

### Total Payload



### Top Basket Capacity

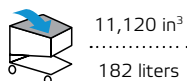

### Nesting Distance

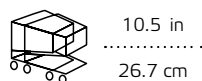

### Weight

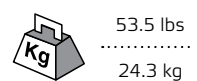

### Trailer Max. Capacity

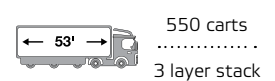



**Wanzl worldwide**

- **Head Office**
- Subsidiaries
- Partners

**WANZL NORTH AMERICA**  
700 Technibilt Drive  
PO Box 310  
Newton, NC 28658

Phone +1 800-351-2278  
Fax +1 800-968-8934

info@wanzl.com  
www.wanzl.com/NA

**GERMANY**  
Wanzl GmbH & Co. KGaA  
Rudolf-Wanzl-Straße 4  
89340 Leipheim

Phone +49 (0) 82 21 / 7 29-0  
Fax +49 (0) 82 21 / 7 29-1000

info@wanzl.com  
www.wanzl.com

Dimensions and specifications are approximate only. Colors are similar to RAL and/or PMS. Designs are subject to changes. Illustrations may show optional equipment and features.  
© Wanzl North America 2020  
**010120a | May 2020**